



## CATALOGUE A102A

### TOOLS AND ACCESSORIES FOR ENGINE REBUILDING EQUIPMENT

#### CONTENT:

PAGE

1.	MANDRELS FOR HORIZONTAL HONING MACHINES .....	3
2.	MANDRELS FOR VERTICAL HONING MACHINES.....	5
3.	STONE SELECTION CHART .....	8
4.	SPECIAL COUPLERS AND SPARE PARTS .....	8
5.	HONING MACHINES.....	9
6.	PORTABLE MANDREL DRIVERS.....	10
7.	TOOLS, ABRASIVE STONES AND ACCESSORIES FOR CK-10, CV-616 AND SIMILAR MACHINES .....	11
8.	HONING OIL.....	13
9.	KIT FOR HONING VALVE GUIDES (KRG1) .....	13
10.	DISASSEMBLY KIT FOR VALVE GUIDES (KDG1).....	13



# MANDRELS FOR HORIZONTAL HONING MACHINES

- CAN BE COUPLED TO HONINGTEC, SUNNEN, DELAPENA HONING MACHINES, ETC.
- SUITABLE FOR HONING CONNECTING RODS, MOTORCYCLE AND COMPRESSOR CYLINDERS, BUSHINGS, GEARS, ETC.

CH SERIES Can also be used for holes with KEYWAY

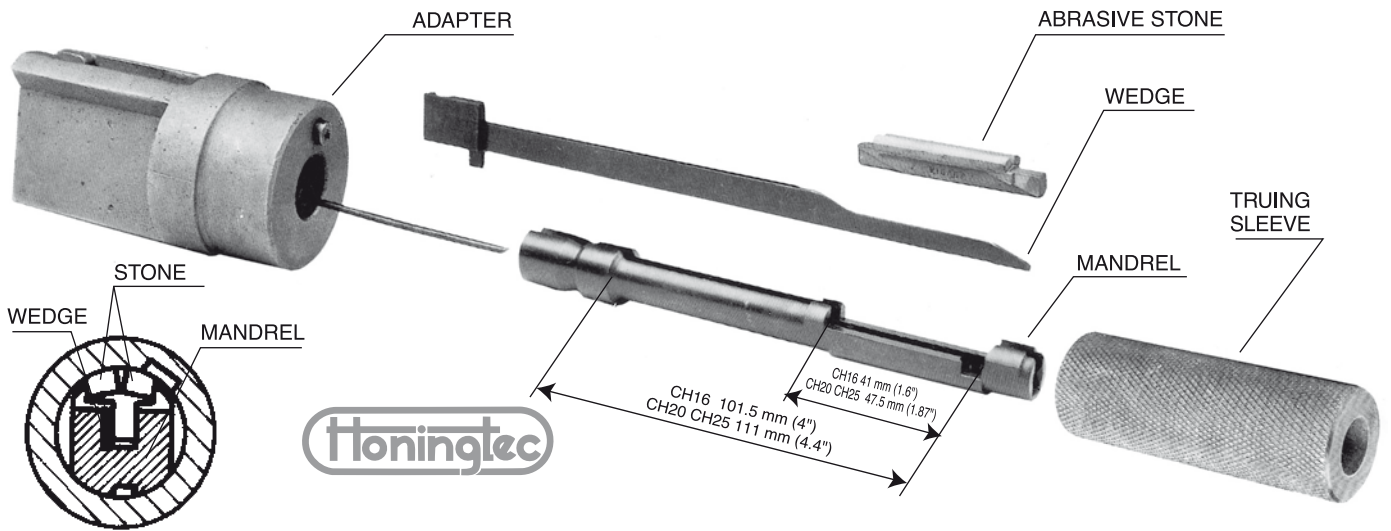

TYPE OF MANDREL	DIAMETER RANGE		MANDREL REFERENCE	ADAPTER	WEDGE	TRUING SLEEVE	TYPE OF STONE	MAX. KEYWAY WIDTH	
	(mm.)	(inch)						(mm.)	(inch)
CH16	12,57 - 13,36	0,495 - 0,526	CH16 1257T	AD16	CH16 C	CR 1257	CH16	3,9	0,154
	13,36 - 14,15	0,526 - 0,557	CH16 1336T						
	14,15 - 14,94	0,557 - 0,588	CH16 1415T						
	14,94 - 15,72	0,588 - 0,619	CH16 1494T						
CH20	15,72 - 16,51	0,619 - 0,650	CH20 1572T	AD20	CH20 C	CR 1572	CH20	5,5	0,216
	16,51 - 17,30	0,650 - 0,681	CH20 1651T						
	17,30 - 18,11	0,681 - 0,713	CH20 1730T						
	18,11 - 18,90	0,713 - 0,744	CH20 1811T						
	18,90 - 19,68	0,744 - 0,775	CH20 1890T						
CH25	19,68 - 20,47	0,775 - 0,806	CH25 1968T	AD25	CH20 C	CR 1968	CH20	5,5	0,216
	20,47 - 21,29	0,806 - 0,838	CH25 2047T						
	21,29 - 22,07	0,838 - 0,869	CH25 2129T						
	22,07 - 22,86	0,869 - 0,900	CH25 2207T						
	22,86 - 23,65	0,900 - 0,931	CH25 2286T						
	23,65 - 24,43	0,931 - 0,962	CH25 2365T						
	24,43 - 25,25	0,962 - 0,994	CH25 2443T						

As the diameter 25.25 (0.994") the guide shoes can be changed when they are worn.

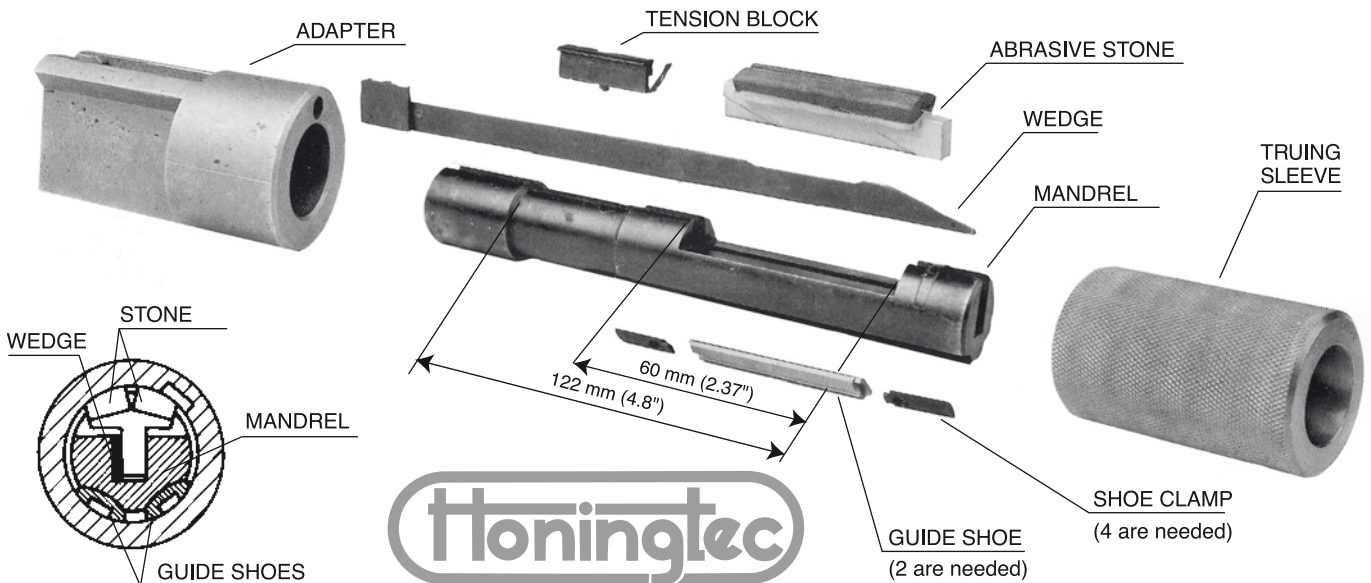

TYPE OF MANDREL	DIAMETER RANGE		MANDREL REFERENCE	ADAPTER	WEDGE	TRUING SLEEVE	SHOE CLAMP	TENSION BLOCK	BRONZE GUIDE SHOE	TYPE OF STONE	MAX. KEYWAY WIDTH	
	(mm.)	(inch)									(mm.)	(inch)
CH35	25,20 - 26,97	0,992 - 1,062	CH35 2520	AD35	CH35 C	CR 2520	CH35 G1 4 shoe clamp + 4 screws set	CH35BP	CH35 Z1B 2 units set	CH35	7,9	0,311
	26,77 - 28,57	1,062 - 1,125	CH35 2677									
	28,37 - 30,15	1,125 - 1,187	CH35 2837									
	29,95 - 31,75	1,187 - 1,250	CH35 2995									
	31,55 - 33,32	1,250 - 1,312	CH35 3155									
	33,12 - 34,92	1,312 - 1,375	CH35 3312									

As of diameter 34.92 (1.375") the adapter is not needed. For each type of mandrel there is a low wedge which must be changed for the high one when the diameter is not reached.

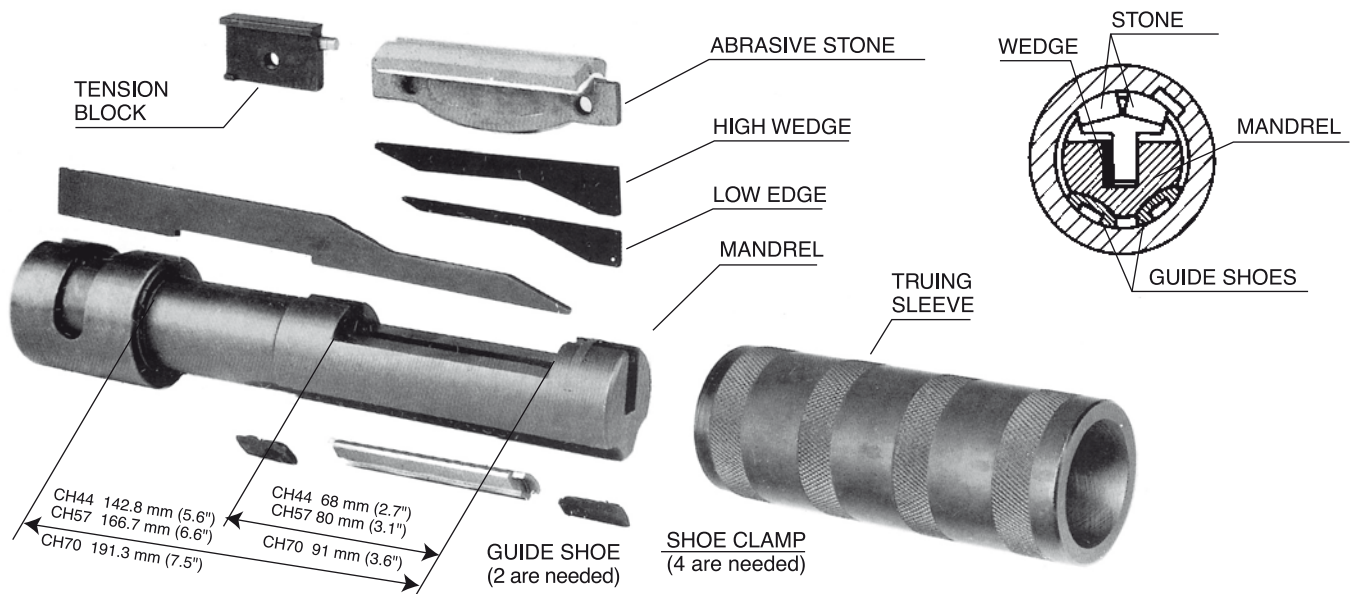

TYPE OF MANDREL	DIAMETER RANGE		MANDREL REFERENCE	PRIMARY WEDGE	SECONDARY WEDGES		TRUING SLEEVE	SHOE CLAMP	TENSION BLOCK	BRONZE GUIDE SHOE	TYPE OF STONE	MAX. KEYWAY WIDTH	
	(mm.)	(inch)			(mm.)	(inch)						(mm.)	(inch)
CH44	34,67 - 38,10	1,365 - 1,500	CH44 3467 CH44 3785 CH44 4102	CH44CP	CH44C1	CH44C2	CR 3467 CR 3785 CR 4102	CH44 G 4 shoe clamp + 4 screws set	CH44BP	CH44 ZB 2 units set	CH44	9,5	0,374
	37,85 - 41,27	1,500 - 1,625											
	41,02 - 44,45	1,625 - 1,750											
CH57	44,20 - 47,62	1,740 - 1,875	CH57 4420 CH57 4737 CH57 5055 CH57 5372	CH57CP	CH57C1	CH57C2	CR 4420 CR 4737 CR 5055 CR 5372	CH57 G 4 shoe clamp + 4 screws set	CH57BP	CH57 ZB 2 units set	CH57	12,7	0,500
	47,37 - 50,80	1,875 - 2,000											
	50,55 - 53,97	2,000 - 2,125											
	53,72 - 57,15	2,125 - 2,250											
CH70	56,90 - 60,32	2,240 - 2,375	CH70 5690 CH70 6007 CH70 6325 CH70 6642	CH70CP	CH70C1	CH70C2	CR 5690 CR 6007 CR 6325 CR 6642	CH70 G 4 shoe clamp + 4 screws set	CH70BP	CH70 ZB 2 units set	CH70	15,8	0,622
	60,07 - 63,50	2,375 - 2,500											
	63,25 - 66,67	2,500 - 2,625											
	66,42 - 69,85	2,625 - 2,750											

**PINION TYPE**

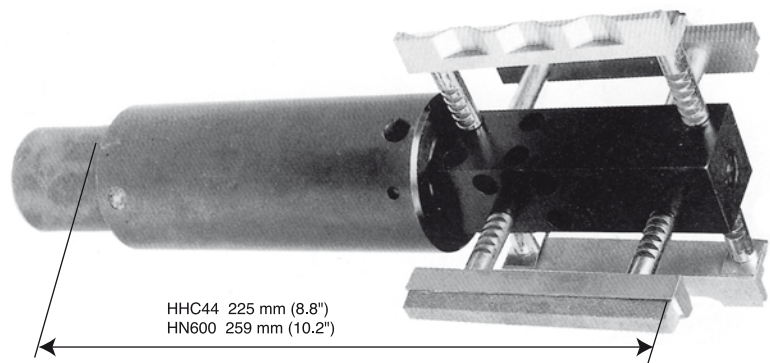

DIAMETER RANGE		TYPE OF MANDREL	TYPE OF STONE			MAX. KEYWAY WIDTH	
(mm.)	(inch)		(see page 7 to choose the abrasive)				
44,0-68,0	1,73-2,67	HHC44	DIAMETER RANGE		REF.		
			(mm.)	(inch.)			
			SET OF 4 DOUBLE STONES				
			44 - 52	1,73 - 2,05	CD44		
52 - 68	2,05 - 2,68	CD52	20	0.787			
63,5-142,0	2,5-5,43	HN600	63,5 - 68,5	2,50 - 2,70	G63		
			68,5 - 104	2,7 - 4,1	M68		
			89 - 140	3,5 - 5,5	N94		
			63,5 - 68,5	2,5 - 2,7	7G63		
			68,5 - 104	2,7 - 4,1	7M68		
			SET OF DOUBLE STONES				
			63,5 - 84	2,5 - 3,3	GY63		20
84 - 106	3,3 - 4,2	MY84	23	0.905			
102 - 142	4,0 - 3,6	NY102	30	1.181			

# MANDRELS FOR VERTICAL HONING MACHINES

- CAN BE COUPLED TO BERCO, ROSSI, ZANROSSO, AMC HONING MACHINES...
- FOR HONING CAR, TRUCK, COMPRESSOR, MOTORCYCLE CYLINDERS...

## HONING MACHINES WITH EXPANSION DEVICE

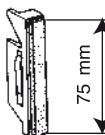
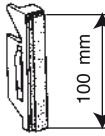

DIAMETER RANGE		TYPE OF MANDREL	TYPE OF STONE (see page 7 to choose the abrasive)			
(mm.)	(inch)		(Ref.)	(mm.)	(inch)	
38-56	1.50-2.20	HBS38	PH38	38.0-44.0	1.50-1.73	
			PH44	44.0-50.0	1.73-1.97	
			PH50	50.0-56.0	1.97-2.20	
44.5-66	1.75-2.60	HBS44	S45	44.5-50.8	1.73-2.00	
			T51	50.8-55.8	2.00-2.20	
			U56	55.8-61.0	2.20-2.40	
			V61	61.0-66.0	2.40-2.60	

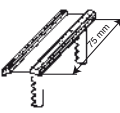
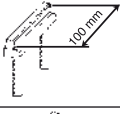
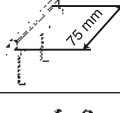
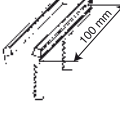

DIAMETER RANGE		TYPE OF MANDREL	TYPE OF STONE (see page 7 to choose the abrasive)			
(mm.)	(inch)		(Ref.)	(mm.)	(inch)	
44-68	1.73-2.67	HBSC44	Sets of 4 double stones			
			CD44	44-52	1.23-2.03	
			CD52	52-68	2.05-2.68	
			G63	63.5-68.5	2.50-2.70	
			M68	68.5-104	2.70-4.10	
			N94	89.0-140	3.50-5.51	
63.5-140	2.50-5.43	HBS63	7G63	63.5-68.5	2.50-2.70	
			7M68	68.5-104	2.27-4.10	
			Sets of double stones			
			GY63	63.5-84	2.50-3.30	
			MY84	84-106	3.30-4.17	
			NY102	102-142	4.00-5.60	

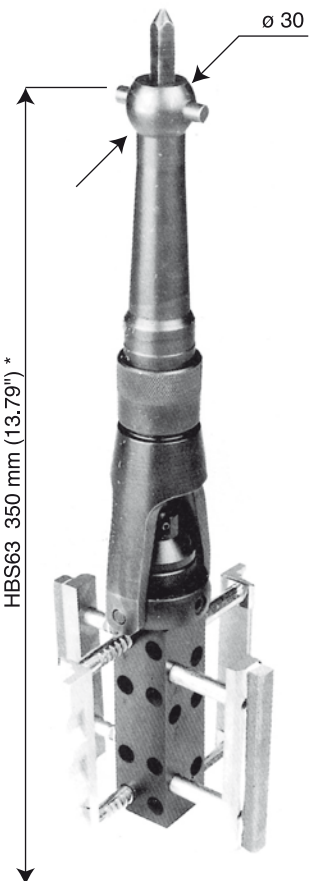

\* Can be manufactured in other lengths

## HONING MACHINES WITHOUT EXPANSION DEVICE

### EXPANSION BY WHEEL-FEED

- CAN BE COUPLED TO LATHES, DRILLS, BORING MACHINES...
- IT IS NOT NECESSARY TO STOP, IN ORDER TO GIVE PRESSURE TO THE STONES.

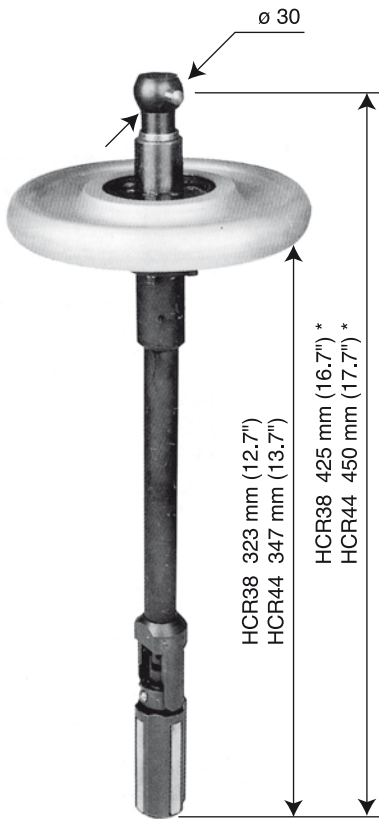

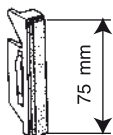
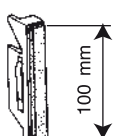
DIAMETER RANGE		TYPE OF MANDREL	TYPE OF STONE (see page 7 to choose the abrasive)			
(mm.)	(inch)		(Ref.)	(mm.)	(inch)	
38-56	1.50-2.20	HCR38	PH38	38.0-44.0	1.50-1.73	
			PH44	44.0-50.0	1.73-1.97	
			PH50	50.0-56.0	1.97-2.20	
44.5-66	1.75-2.60	HCR44	S45	44.5-50.8	1.73-2.00	
			T51	50.8-55.8	2.00-2.20	
			U56	55.8-61.0	2.20-2.40	
			V61	61.0-66.0	2.40-2.60	

HBS 38 and HBS44 cannot be coupled to machines in which the stroke is an arc (Rocker type and similar).

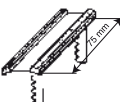
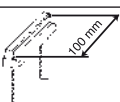
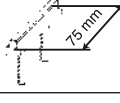
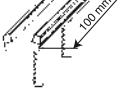

DIAMETER RANGE		TYPE OF MANDREL	TYPE OF STONE (see page 7 to choose the abrasive)			
(mm.)	(inch)		(Ref.)	(mm.)	(inch)	
44-68	1.73-2.67	HCRC44	Sets of 4 double stones			
			CD44	44-52	1.23-2.03	
63.5-140	2.50-5.43	HCR63	CD52	52-68	2.05-2.68	
			G63	63.5-68.5	2.50-2.70	
			M68	68.5-104	2.70-4.10	
			N94	89.0-140	3.50-5.51	
			7G63	63.5-68.5	2.50-2.70	
			7M68	68.5-104	2.27-4.10	
			Sets of double stones			
GY63	63.5-84	2.50-3.30				
MY84	84-106	3.30-4.17				
NY102	102-142	4.00-5.60				

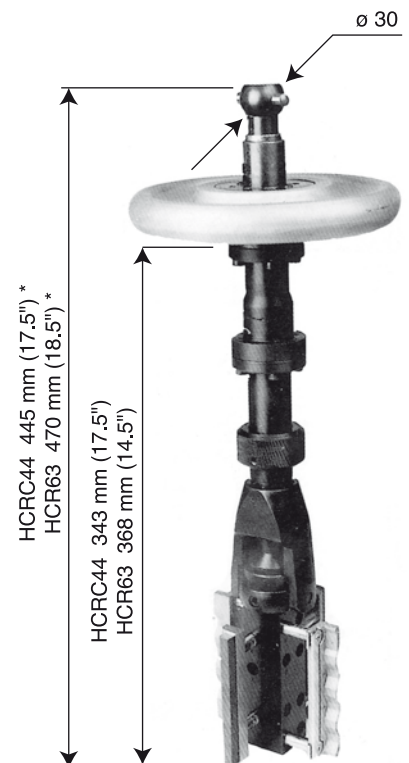

\* Can be manufactured in other lengths

**MANUAL EXPANSION**

– CAN BE COUPLED TO LATHES, PROTABLE DRILLS, DRILLS, BORING MACHINES...

Note: Photography shows the mandrel for portable drills (standard version). If you need this mandrel for lathes, column drills, boring machines or machines with rigid axis, it is necessary to use ACB12 or ACC3 coupler and B30M12 ball.

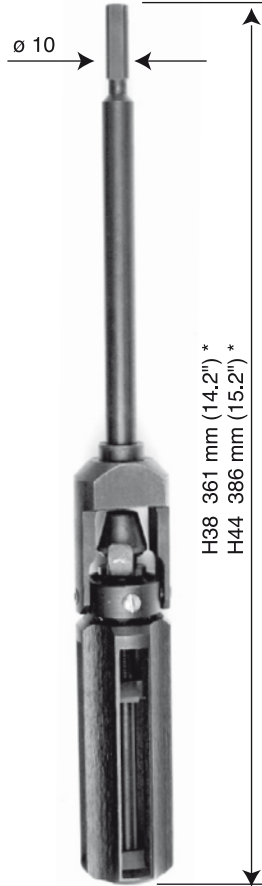

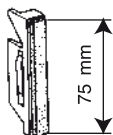
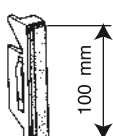
DIAMETER RANGE		TYPE OF MANDREL	TYPE OF STONE (see page 7 to choose the abrasive)			
(mm.)	(inch)		(Ref.)	(mm.)	(inch)	
38-56	1.50-2.20	H38	PH38	38.0-44.0	1.50-1.73	 75 mm
			PH44	44.0-50.0	1.73-1.97	
			PH50	50.0-56.0	1.97-2.20	
44.5-66	1.75-2.60	H44	S45	44.5-50.8	1.73-2.00	 100 mm
			T51	50.8-55.8	2.00-2.20	
			U56	55.8-61.0	2.20-2.40	
			V61	61.0-66.0	2.40-2.60	

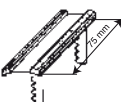
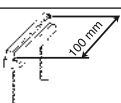
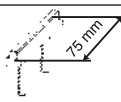

DIAMETER RANGE		TYPE OF MANDREL	TYPE OF STONE (see page 7 to choose the abrasive)			
(mm.)	(inch)		(Ref.)	(mm.)	(inch)	
44-68	1.73-2.67	HC44	Sets of 4 double stones			 75 mm
			CD44 CD52	44-52 52-68	1.23-2.03 2.05-2.68	
63.5-140	2.50-5.43	H63	G63	63.5-68.5	2.50-2.70	 100 mm
			M68	68.5-104	2.70-4.10	
			N94	89.0-140	3.50-5.51	
			7G63 7M68	63.5-68.5 68.5-104	2.50-2.70 2.27-4.10	 75 mm
			Sets of double stones			
			GY63 MY84 NY102	63.5-84 84-106 102-142	2.50-3.30 3.30-4.17 4.00-5.60	



\* Can be manufactured in other lengths

## STONE SELECTION CHART

This table shows the recommended abrasives. If you wish to optimize the performance, please consult our technical department.

Many other kinds of abrasives, hardnesses and granulometrics are available as well as special measurements for other types of honing heads.

Diamond and borazon Honing stones are made by request (for chrome, nicasyl, bimetal...)

	BIG ROUGHING	ROUGHING	FINISHING	POLISHING
Motorcycle connecting rods			H1514	E1912
Car and truck connecting rods		H1314	E1614	
Cast iron cylinder block	E1016	E1316	E1516	
Valve guides			E1614	
Bronze, aluminium		E1314	E1612	E1910

## SPECIAL COUPLERS AND SPARE PARTS

As well as the couplers on this table, special couplers can be manufactured for any machine.

	REF.	HONING HEADS WHICH THEY ARE COUPLED TO	
	AC1612	H38, H44, HC44	Special machines
	AC1616	H63	
	AC1212	H38, H44, HC44	Portable drills
	AC1216	H63	
	ACB12	HCR38, HCR44, HCRC44, HCR63, H38, H44, HC44, H63, The 30 mm diam. ball is coupled directly to it.	Lathes, drills, other machines
	ACC3	HCR38, HCR44, HCRC44, HCR63, H38, H44, HC44, H63, The 30 mm diam. ball is coupled directly to it.	Radial drills, etc.
	B30M16	M16 thread for heavy serie extensions.	Complementary to ACB12 or ACC3 couplers
	B30M12	M12 thread for light serie extensions.	
	CE6	HBS63, HCR63	
	CE7	HBSC44, HCRC44	
	CE3	H63	
	CE8	HC44	
	CE4	HBS38, HCR38	
	CE1	H38	
	CE5	HBS44, HCR44	
	CE2	H44	



## HONING MACHINES

### BM101 TABLE-TOP HORIZONTAL HONING MACHINE



The BM101 Horizontal Honing Machine is an easy-to-use, hand-operated, high-honing precision unit. Due to its compact design and low weight, this honing machine is extremely easy to use. It can be used for honing a wide and diverse range of diameters ranging between 5 and 100 mm (depending on whether it is machine version A or B), working at spinning speeds from 95 up to 1150 rpm (A or B) according to the diameter of the part to be honed.

The BM101 honing machine features the latest technology. It is fitted with a system that constantly monitors the pressure applied on the stones, thus optimising the quality of the part.

This extremely easy-to-use honing machine requires a minimum degree of maintenance.

Being so easy to handle, it can be set up quickly and thus saves a considerable length of time.

Suitable for honing motorcycle and compressor cylinders, connecting rods, garden tractors, bushings, gears, distributors, etc.

For further information ask for catalogue 174.



### BVD450 VERTICAL HONING MACHINE

A vertical honing machine suitable for industrial repairs of large compressors, cylinders block, hydraulic cylinders,...

Great versatility and easy to prepare and handle.

Diameter range from 38 to 450 mm and a maximum length of 2000 mm (Depending to the version).

There are different versions with different powers and capacities.

For further information ask for catalogue 192 A.

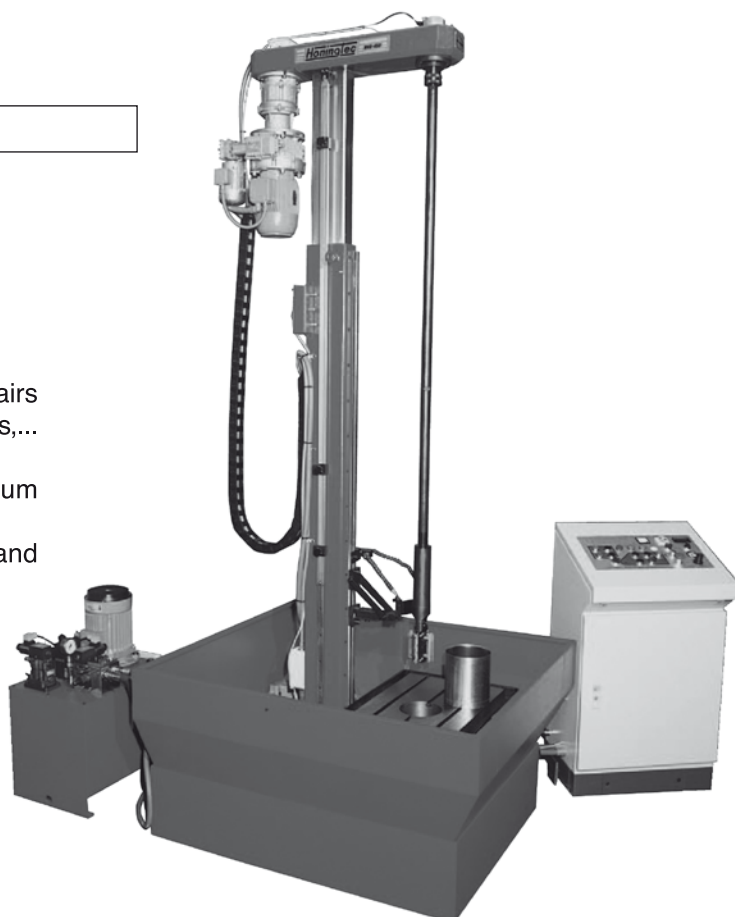

## PORTABLE MANDREL DRIVERS

These couplers allow the CH, K, L and P, HN600, HHC44 mandrels of the horizontal honing machines to be used in portable drills.

They are suitable for anyone who does not have a horizontal honing machine or for those parts which, because of their geometry or weight, are difficult to hone by machine, as well as door to door repairs.

### PBT1 COUPLER

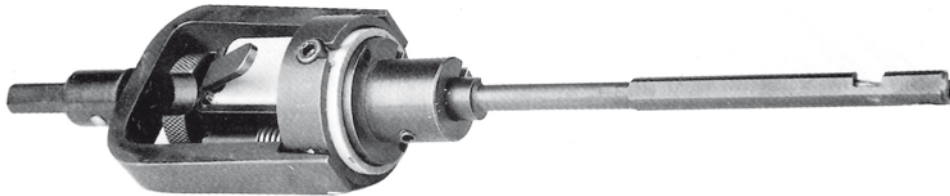

For 4,70 to 31,75 mm diameter range.

The anchorage is 10 mm in diameter and a portable drill with a speed of between 400 and 600 rpm is recommended.

DIAMETER RANGE		ADAPTER	
(mm.)	(inch)		
4.70-6.23	0.185-0.245	A63	The tool and abrasive should be chosen as for a horizontal machine.
6.23-7.82	0.245-0.308	A80	
7.82-9.40	0.308-0.370	A95	
9.40-12.58	0.370-0.495	A127	
12.58-15.72	0.495-0.619	A160	
15.72-18.89	0.619-0.744	A190	
18.89-31.75	0.744-1.250	A254	

### PBT2 COUPLER

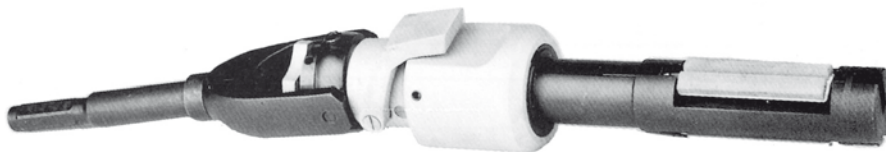

Diameter range from 18.9 to 142 mm.

This allows the mandrels to be coupled just as they are coupled to the horizontal machine, that is to say, you must have a mandrel and its corresponding adaptor (see tables).

The anchorage is 12.7 mm and a portable drill with a speed of between 200 and 300 rpm is recommended.



# TOOLS; ABRASIVE STONES AND ACCESORIES FOR CK-10, CV-616 AND SIMILAR MACHINES

## BRONZE GUIDE SHOES

Shoes in high resistance bronze.



MEASUREMENTS	REF. (Set of 2 u.)	EQUIVALENT
32 x 8 x 6.35	ZCK1	CK2120
32 x 8 x 8.8	ZCK2	CK2140
76 x 8.25 x 4.4	ZCK3	CK2028
76 x 8.25 x 6.35	ZCK4	CK2070
38 x 12.7 x 9.5	ZCK5	CK3120
88 x 9.5 x 9.5	ZCK6	CK3070

## DIAMONDS SETS

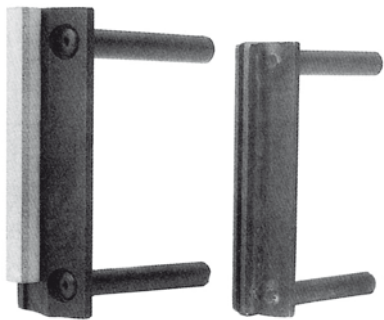

Full set ready to be installed in the honing head.  
Great cutting power. Recommended for roughing.

REFERENCE	GRAIN	HONING HEAD
CK2045D	D181	MIDGET
CK3045D	D181	STANDARD JUNIOR

- \* Diamond is not recommended for the finish.
- \* Diamond set CK2035D is obtained from CK2045D set and cutting the legs 6.5 mm (0,256 inch).
- \* Diamond set CK3035D is obtained from CK3045D set and cutting the legs 11 mm (0,433 inch).



## TYPE OF MANDREL



DIAMETER RANGE		TYPE OF MANDREL	TYPE OF STONE (see page 7 to choose the abrasive)			Diagram
(mm.)	(inch)		(Ref.)	(mm.)	(inch)	
38-56	1.50-2.20	HCK38	PH38	38.0-44.0	1.50-1.73	
			PH44	44.0-50.0	1.73-1.97	
			PH50	50.0-56.0	1.97-2.20	
44.5-66	1.75-2.60	HCK44	S45	44.5-50.8	1.73-2.00	
			T51	50.8-55.8	2.00-2.20	
			U56	55.8-61.0	2.20-2.40	
			V61	61.0-66.0	2.40-2.60	
63.5-140	2.50-5.43	HCK63	G63	63.5-68.5	2.50-2.70	
			M68	68.5-104	2.70-4.10	
			N94	89.0-140	3.50-5.51	
			7G63	63.5-68.5	2.50-2.70	
			7M68	68.5-104	2.20-4.10	
			Sets of double stones			
		GY63	63.5-84	2.50-3.30		
MY84	84-106	3.30-4.17				
		NY102	102-142	4.00-5.50		

\* Can be manufactured in other lengths

## ABRASIVE STONES SET

The reference describes the type of support, the length and the height of the abrasive. The quality of the abrasive desired should be stated along with the reference.

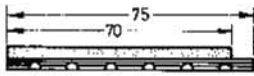
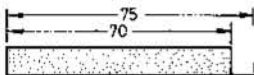
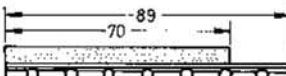
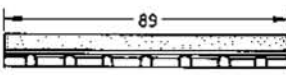
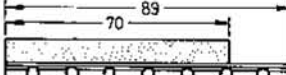
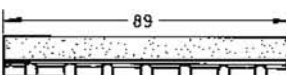
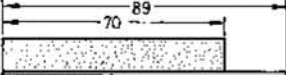
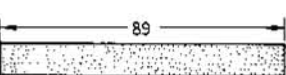

**Honingtec**

	REF.	EQUIVALENT
	PCK1	EEU
	PCK2	EAU
	PCK3	EMU
	PCK4	EMN
	PCK5	EKU
	PCK6	EKN
	PCK7	EHU
	PCK8	EHN

### RECOMMENDED ABRASIVES

ROUGHING: C-916 (white)  
E-1016 (black)

FINISHING: C-1516 (white)  
E-1516 (black)

Special abrasives are available for any material.

## FILTERS

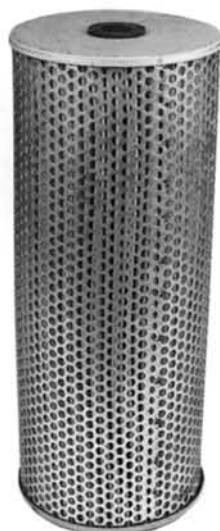

Can be adapted to CK10, CV616 honing machines and PF150 filtering equipment.  
Filtration threshold: 20µm.

FCK-10

**Honingtec**

## HONING OIL

The honing oil is especially to obtain the maximum performance of the abrasive and the tool.  
Great decanting, cooling and cleaning power of the abrasive.



OHB14-25	25 l. drum
OHB14-50	50 l. drum
OHB14-200	200 l. drum

## KIT FOR HONING VALVE GUIDES (KRG1)



Includes:

- PBT1 Mandrel holder which can be coupled to portable drill.
- A63, A80, A95, A127 adaptors.
- Mandrels for:
 

diam. 6 mm	HBL6 584T
diam. 7 mm	HBL8 686T
diam. 8 mm	HBL10 782T
diam. 9 mm	HBL10 881T
diam. 10 mm	HBL12 978T
diam. 11 mm	HBL12 1057T
- 6 stones HL6 E1616
- 6 stones HL8 E1616
- 6 stones HL10 E1616
- 6 stones HL12 E1616
- Box.
- Instructions manual

Use new stones to cover the biggest diameters of the range and reserve the weared ones for smaller diameters of the range  
For using with a portable drill with a rpm of between 400 and 600 rpm.

Anchorage 10 mm in diameter.

Other kit composition are possible.

## DISASSEMBLY KIT FOR VALVE GUIDES (KDG1)



For disassembling the guide valves pneumatically and quickly.

Includes:

- PND1 Pneumatic gun.
- 10 guide pilots of different diameters.
- Box.



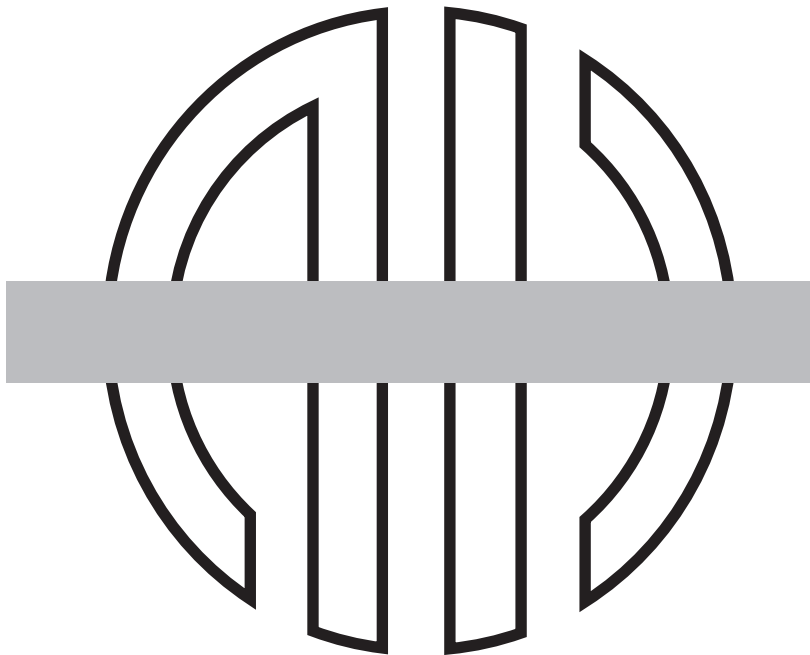

**NOTE:** We reserve the right to change specifications without prior warning.

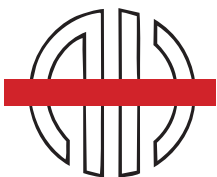

## **HONINGTEC, S.A.**

C/ Sant Jaume, 8-14  
08550 HOSTALETS DE BALENYÀ  
Barcelona (Espanya)  
Tel. 34-93 889 84 10 / 34-93 889 80 44  
Fax 34-93 889 82 76  
e-mail: [honingtec@honingtec.com](mailto:honingtec@honingtec.com)  
<http://www.honingtec.com>

DISTRIBUTOR